



Smith & Wesson®

SAFETY & INSTRUCTION MANUAL For The M&P® 22 MAGNUM Pistol



M&P® 22 MAGNUM



**Read the instructions and
warnings in this manual
CAREFULLY BEFORE
using this firearm.**

2100 Roosevelt Avenue • Springfield, MA 01104
1-800-331-0852 ext. 4125 • Fax: 413-747-3317
www.smith-wesson.com

Copyright 2023 Smith & Wesson Inc. All rights reserved.



WARNING:



**READ THESE INSTRUCTIONS
AND WARNINGS CAREFULLY.
BE SURE YOU UNDERSTAND THESE
INSTRUCTIONS AND WARNINGS
BEFORE USING THIS FIREARM.
FAILURE TO READ THESE INSTRUCTIONS
AND TO FOLLOW THESE WARNINGS MAY
RESULT IN INJURY OR DEATH
TO YOU AND OTHERS AND
DAMAGE TO PROPERTY.**

**THIS SAFETY & INSTRUCTION
MANUAL SHOULD ALWAYS
ACCOMPANY THIS FIREARM AND
BE TRANSFERRED WITH IT UPON CHANGE
OF OWNERSHIP OR WHEN PRESENTED
TO ANOTHER PERSON.**

**A COPY OF THE SAFETY & INSTRUCTION
MANUAL IS AVAILABLE FREE
VIA DOWNLOAD AT
WWW.SMITH-WESSON.COM
OR UPON REQUEST FROM:**

**SMITH & WESSON®
CUSTOMER SUPPORT CENTER
2100 ROOSEVELT AVENUE
SPRINGFIELD, MA 01104
TEL.: 1-800-331-0852, ext. 4125
E-mail: qa@smith-wesson.com**

TABLE OF CONTENTS

YOUR SAFETY RESPONSIBILITIES	3-6
SAFE STORAGE AND TRANSPORTATION.....	7-8
AMMUNITION	8-10
MODEL AND FEATURES IDENTIFICATION	11
MANUAL THUMB SAFETY LEVER	12
INSPECTING YOUR PISTOL	13-14
PREPARATION FOR FIRING.....	15
LOADING.....	16-18
FIRING	18-20
HANGFIRES AND MISFIRES.....	20-22
CLEARING A MISFEED/JAM	22-23
UNLOADING	23-24
FIELD STRIPPING/DISASSEMBLY	25-29
LUBRICATION	30
ASSEMBLY	30-33
MAGAZINE FOR THE M&P® 22 MAGNUM	34-35
REVERSIBLE MAGAZINE RELEASE	36-37
REAR SIGHT ADJUSTMENT.....	38
CLEANING AND MAINTENANCE	39-41
LIMITED WARRANTY - For Owners Within The United States.....	42-43
CONTACT AND SHIPPING INFORMATION - For Owners Within The United States..	43-45
OPTICAL SIGHT MOUNTING INSTRUCTIONS.....	46-47
CUSTOM SERVICE	48
BATTERY WARNINGS.....	49
INTERNATIONAL WARRANTY CENTERS, PATENT INFORMATION.....	50

YOUR SAFETY RESPONSIBILITIES

SAFETY IS YOUR NUMBER ONE RESPONSIBILITY!

- At home, in the field, at the range, or anywhere, the first concern of every firearm owner should be safety. Apply the following safety rules in every situation, with any kind of firearm. If you feel uncertain about any operational aspects of your firearm, please contact Smith & Wesson® at 1-800-331-0852, ext. 4125 before proceeding with its operation.
- If you are unfamiliar with firearms, you should seek formal training before using your pistol.



WARNING: YOU MUST FOLLOW ALL OF THESE SAFETY RULES TO ENSURE THE SAFE USE OF YOUR FIREARM. THE FAILURE TO FOLLOW THE INSTRUCTIONS AND WARNINGS IN THIS MANUAL COULD CAUSE PERSONAL INJURY OR DEATH TO YOU OR OTHERS AND DAMAGE TO PROPERTY.

- As a firearm owner, you accept a demanding responsibility. How seriously you take this responsibility can be the difference between life and death. There is no excuse for careless or abusive handling of your firearm. At all times, handle your firearm with intense respect for its power and potential danger.



YOUR SAFETY RESPONSIBILITIES - CONTINUED

- **ALWAYS KEEP YOUR FIREARM POINTED IN A SAFE DIRECTION.** Never point a firearm at anyone or anything you do not intend to shoot whether or not it is loaded. This is particularly important when loading, unloading, or field stripping the gun. ALWAYS control the direction of the firearm.
- **ALWAYS TREAT EVERY FIREARM AS IF IT IS LOADED AND WILL FIRE.** Do not take anyone's word that the firearm is unloaded – always check for yourself. Never pass your firearm to another person until the cylinder or action is open and you visually check that it is unloaded. Keep your firearm unloaded and safely stored when not in use.
- **NEVER PLACE YOUR FINGER INSIDE THE TRIGGER GUARD OR ON THE TRIGGER UNLESS YOU INTEND TO FIRE.** Ensure that other objects do not touch the trigger.
- **ALWAYS BE SURE OF YOUR TARGET AND WHAT IS BEYOND IT.** Always be sure of where the bullet will strike and shoot only where there is a safe backstop free of obstructions, water or other surfaces which can cause ricochets. Be sure your bullet will stop behind your target. Bullets can glance off many surfaces like rocks or the surface of water and travel in unpredictable directions with considerable velocity. Do not fire randomly into the sky.
- **NEVER CROSS OBSTACLES SUCH AS FENCES OR STREAMS WITH A LOADED FIREARM.** Always make certain your firearm is unloaded before crossing a fence, climbing a tree, jumping a ditch, or negotiating any other obstacles.
- **SAFE GUN HANDLING IS YOUR PERSONAL RESPONSIBILITY AT ALL TIMES.** Firearms are dangerous and can cause injury or death if they are misused or used inappropriately. Safety must be the prime consideration of anyone who owns or handles firearms. Accidents are the result of violating the rules of safe gun handling and common sense. Firearm safety training is available. Contact your firearms dealer, law enforcement agency, local sportsman's club, or other such similar entities for availability.
- **YOU ARE RESPONSIBLE FOR THE FIREARM AT ALL TIMES.** In owning a firearm, you must undertake full-time responsibility for your firearm. You must protect yourself and all others against injury or death from misuse of the firearm 24 hours a day.
- **FIREARM SECURITY IS YOUR RESPONSIBILITY.** You must secure firearms safely from children and/or unauthorized users. Your firearm must always be kept unloaded and locked when not in use. A lock has been provided for this purpose. Never assume that the use of this lock is sufficient to safely secure your firearm. You must always evaluate your personal situation and employ the security systems that meet your needs and prevent children and unauthorized users from gaining access to your firearm.



YOUR SAFETY RESPONSIBILITIES - CONTINUED

- **APPROPRIATE USE FOR YOUR FIREARM MEANS USING YOUR FIREARM FOR LEGAL PURPOSES.** Legal purposes include - target shooting, hunting, and lawful resistance of deadly criminal force. It is your responsibility to ensure that you are in compliance with all applicable laws and ordinances regarding the use of your firearm.
- **NEVER RELY ON MECHANICAL FEATURES ALONE.** Only your safe gun-handling habits will ensure the safe use of your firearm. This is your responsibility.
- **ALWAYS SAFELY STORE AND SECURE YOUR FIREARM.** Safe and secure storage of your firearm is one of your most important responsibilities. It is a full-time responsibility. You must always secure your firearm and ammunition separately so that they are not accessible to children and/or other unauthorized persons.
- **NEVER KEEP AMMUNITION IN THE SAME LOCATION AS THE FIREARM.** Store your firearm and ammunition each in a separate and secure place.
- **ALWAYS WEAR EYE PROTECTION THAT IS SPECIFIED FOR USE WITH FIREARMS EVERY TIME YOU HANDLE YOUR FIREARM FOR CLEANING AND MAINTENANCE.**
- **ALWAYS WEAR EYE AND HEARING PROTECTION THAT ARE SPECIFIED FOR USE WITH FIREARMS EVERY TIME YOU DISCHARGE YOUR FIREARM.** Make sure others in the vicinity of where you will be shooting do so as well.
- **NEVER USE ALCOHOL OR DRUGS BEFORE OR WHILE SHOOTING.** Do not use your firearm if you are on any medication which impairs, even slightly, your mental or physical ability.
- **ALWAYS HAVE ADEQUATE VENTILATION.** Discharging firearms in poorly ventilated areas, cleaning firearms, or handling ammunition may result in exposure to lead and other substances known to cause birth defects, reproductive harm, and other physical injury. Review the warnings and labels for all ammunition and cleaning products carefully. Wash hands thoroughly after exposure.
- **BEFORE HANDLING ANY FIREARM, UNDERSTAND ITS OPERATION.** Not all firearms are the same. Familiarize yourself with the mechanical features of any firearm you intend to use. If you feel uncertain about any operational aspects of your firearm, please contact Smith & Wesson® at 1-800-331-0852, ext. 4125 before proceeding with its operation.
- **NEVER ALLOW A FIREARM TO BE USED BY ANY INDIVIDUAL WHO DOES NOT UNDERSTAND ITS SAFE OPERATION OR HAS NOT READ THIS SAFETY AND INSTRUCTION MANUAL.**

YOUR SAFETY RESPONSIBILITIES - CONTINUED

- **ALWAYS USE THE CORRECT AMMUNITION FOR YOUR PARTICULAR FIREARM AS INDICATED BY THE MARKING ON THE FIREARM.** Never use non-standard, damaged, corroded, reloaded, or handloaded ammunition which has not been subjected to internal ballistic pressure testing.
- **BEWARE OF BARREL BORE OBSTRUCTIONS.** Be sure the barrel bore is clear of obstructions before shooting. Mud, water, snow, or other objects may inadvertently lodge in the barrel bore. A small obstruction can cause a dangerous increase in pressure and cause injury to yourself and others and may damage your gun.
- **BE SURE ALL HOLSTERS, GRIPS, AND OTHER ACCESSORIES ARE COMPATIBLE WITH THE FIREARM AND THAT THE ACCESSORIES DO NOT INTERFERE WITH SAFE OPERATION.** It is your responsibility to understand and follow all of the instructions in this manual, as well as those which may be supplied with your ammunition and any accessory.
- **NEVER DISASSEMBLE YOUR FIREARM BEYOND THE FIELD STRIPPING PROCEDURE OUTLINED IN THIS MANUAL.** Improper disassembly or reassembly of your firearm may be dangerous and can lead to injury or death.
- **NEVER MANIPULATE, ADJUST OR CHANGE ANY OF THE INTERNAL COMPONENTS OF YOUR FIREARM UNLESS SPECIFICALLY INSTRUCTED TO DO SO IN THIS MANUAL.** Improper manipulation of any internal component may affect the safety and reliability of your firearm and may cause injury or death.
- **NEVER ALLOW ANY ALTERATION OR REPLACEMENT OF PARTS IN YOUR SMITH & WESSON® FIREARM UNLESS PERFORMED BY A QUALIFIED GUNSMITH USING GENUINE SMITH & WESSON® PARTS.** If you do otherwise, improper functioning of your firearm may occur and injury or death and damage to property may result.



WARNING: SAFE USE OF A FIREARM IS YOUR PERSONAL RESPONSIBILITY AND THE FAILURE TO FOLLOW ALL OF THESE BASIC SAFETY RULES MAY RESULT IN SEVERE PERSONAL INJURY OR DEATH TO YOU OR OTHERS AND DAMAGE TO PROPERTY. YOU ARE THE MOST IMPORTANT SAFETY DEVICE WHEN IT COMES TO THE USE OF YOUR FIREARM AND SMITH & WESSON® WILL NOT BE RESPONSIBLE FOR ANY PERSONAL INJURY, DEATH OR PROPERTY DAMAGE THAT RESULTS FROM: (1) THE CRIMINAL OR NEGLIGENT USE OF THIS FIREARM; (2) A DISREGARD OF THESE SAFETY INSTRUCTIONS AND WARNINGS; (3) IMPROPER OR CARELESS HANDLING OF THIS FIREARM; (4) THE USE OF NON-STANDARD, DEFECTIVE OR IMPROPER AMMUNITION OR; (5) IMPROPER OR NEGLIGENT MODIFICATIONS OR REPAIRS TO THE FIREARM.

SAFE STORAGE AND TRANSPORTATION



WARNING: ALWAYS KEEP THE MUZZLE OF THE PISTOL POINTED IN A SAFE DIRECTION.



WARNING: FIREARMS ARE DANGEROUS WHEN USED AND STORED IMPROPERLY. THEY POSE A RISK OF INJURY OR DEATH. FIREARMS CAN BE ESPECIALLY DANGEROUS TO CHILDREN WHEN THEY ARE STORED IN AN IRRESPONSIBLE AND UNSAFE MANNER. FOR YOUR SAFETY AND THE SAFETY OF OTHERS, IT IS IMPERATIVE THAT YOU KEEP YOUR FIREARM LOCKED AND UNLOADED IN A SECURE PLACE. THE AMMUNITION SHOULD BE STORED IN A SEPARATE, SECURE LOCATION WHEN IT IS NOT IN USE. SAFE AND SECURE STORAGE OF YOUR FIREARM IS ONE OF THE MOST IMPORTANT RULES OF FIREARM SAFETY. FAILURE TO FOLLOW THESE RULES MAY RESULT IN INJURY OR DEATH TO YOU OR OTHERS.

- **ALWAYS SECURE YOUR FIREARM IN A MANNER THAT WILL PREVENT UNAUTHORIZED ACCESS.** Whenever your firearm is not in use, keep it unloaded and locked. Your safety and the safety of others requires that you always secure and store your firearm in a manner that will prevent unauthorized access. Never leave a firearm unattended unless it is locked, unloaded, and secured.
- **ALWAYS USE THE LOCK PROVIDED BY SMITH & WESSON TO SECURE YOUR FIREARM.** Please read and follow the instructions packaged separately for the use of this lock. A lock, when properly used, can be an effective tool in preventing unauthorized access to your firearm. There are other alternative locks and safe storage containers available in the marketplace which may also be appropriate for your particular needs. Consult your local gun shop, hardware store, or local police department for guidance on the variety of other safe storage devices or practices which may be appropriate for your particular needs. By purchasing this firearm you have accepted the responsibility of safely securing the firearm at all times and preventing its unauthorized use. Never assume that the use of this lock alone is sufficient to safely secure your firearm. It is your personal responsibility to select and use whatever measures or practices that will enable you to be absolutely certain that your firearm is secure at all times.



WARNING: NEVER LOCK A LOADED FIREARM AND NEVER LOAD A LOCKED FIREARM!

- **ALWAYS STORE YOUR FIREARM AND AMMUNITION SEPARATELY SO THAT THEY ARE NOT ACCESSIBLE TO CHILDREN OR OTHER UNAUTHORIZED PERSONS.** Safe and secure storage of your firearm and ammunition are your responsibility. It is a full-time responsibility.

SAFE STORAGE AND TRANSPORTATION - CONTINUED

- **NEVER ASSUME THAT A “HIDING” PLACE IS A SECURE STORAGE METHOD.** Others may be aware of your storage location or come upon it by chance. It is your personal responsibility to use common sense when storing your firearm and ammunition and to always make sure they are not accessible to children or other unauthorized persons.
- **NEVER TRANSPORT A LOADED FIREARM.** When transporting your firearm, be sure it is unloaded and locked. Safe and secure transportation of your firearm is your responsibility.
- **ALWAYS FOLLOW THE LAW!** Many jurisdictions have laws that make it a crime to keep a firearm unlocked and in an area accessible to children or others. Keeping a firearm locked and unloaded when not in use is not only common sense safety practice... IT IS THE LAW. You must be familiar with all local, state, and federal laws regarding the safe storage and transportation of your firearm. Failure to know and follow the law may result in unauthorized access or use of your firearm by another. Obey all laws relating to the storage and transportation of firearms. Your local police department or gun shop can furnish you with available information on storing and/or transporting a firearm safely and legally.
- **YOUR FIREARM IS YOUR RESPONSIBILITY.** You must prevent your firearm from being stolen or from being used by untrained or unqualified individuals. Keep it locked, unloaded, and secured when not in use.
- Never leave the key with the stored firearm.

AMMUNITION



WARNING: NEVER USE AMMUNITION NOT SPECIFICALLY DESIGNATED FOR USE IN YOUR FIREARM. FAILURE TO USE THE CORRECT TYPE OR CALIBER OF AMMUNITION MAY CAUSE THE FIREARM TO JAM, FAIL TO FIRE, OR MAY GENERATE EXCESSIVE PRESSURE WHICH CAN DAMAGE OR EVEN RUPTURE YOUR FIREARM, CAUSING PERSONAL INJURY OR DEATH TO THE SHOOTER AND/OR BYSTANDERS.

- Locate the cartridge designation marked on the firearm. This information indicates the correct ammunition that must be used in this firearm (FIGURE 1).
- You are responsible for selecting ammunition that meets industry standards and is appropriate in type and caliber for this firearm.

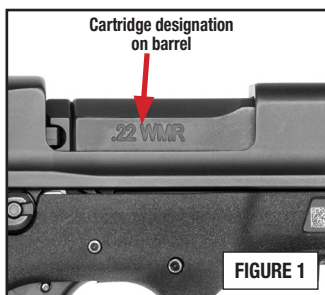

AMMUNITION - CONTINUED

- Never mix ammunition.



WARNING: IN SOME CASES, A ROUND OF AMMUNITION NOT SPECIFIED ON YOUR FIREARM AND NOT LISTED AS ALTERNATE AMMUNITION IN THIS MANUAL MAY FIT INTO THE CHAMBER. FIRING THIS AMMUNITION MAY CAUSE A RUPTURE, RESULTING IN PERSONAL INJURY OR DEATH TO THE SHOOTER AND/OR BYSTANDERS AND DAMAGE TO PROPERTY.

FOR MORE INFORMATION REGARDING *GENERALLY ACCEPTED FIRE-ARMS AND AMMUNITION INTERCHANGEABILITY*, AS PUBLISHED BY SPORTING ARMS AND AMMUNITION MANUFACTURERS' INSTITUTE (SAAMI), FIND IT AT [HTTPS://SAAMI.ORG](https://saami.org)



WARNING: ALWAYS INSPECT YOUR AMMUNITION BEFORE USING IT. NEVER USE DIRTY, CORRODED OR DAMAGED AMMUNITION. A BURST CARTRIDGE OR BORE OBSTRUCTION MAY RESULT CAUSING DAMAGE TO THE FIREARM AND PERSONAL INJURY OR DEATH TO THE SHOOTER AND/OR BYSTANDERS.



WARNING: DISCHARGING FIREARMS IN POORLY VENTILATED AREAS, CLEANING FIREARMS, OR HANDLING AMMUNITION MAY RESULT IN EXPOSURE TO LEAD AND OTHER SUBSTANCES KNOWN TO CAUSE BIRTH DEFECTS, REPRODUCTIVE HARM AND OTHER PHYSICAL INJURY. HAVE ADEQUATE VENTILATION AT ALL TIMES. WASH HANDS THOROUGHLY AFTER EXPOSURE.



WARNING: THE SMITH & WESSON® M&P® 22 MAGNUM PISTOL IS COMPATIBLE WITH NEW, FACTORY LOADED AMMUNITION CONFORMING TO SAAMI STANDARDS. THE USE OF NON-STANDARD AMMUNITION MAY CAUSE INJURY AND/OR DEATH TO THE SHOOTER OR BYSTANDERS AND DAMAGE TO PROPERTY.

- A firearm and its ammunition are a system and must work together. There are different types of ammunition for different types of firearms. Your firearm has been designed for ammunition of a specific type and a specific gauge or caliber. It is important to select the proper ammunition for your firearm.
- Some brands of ammunition may cause difficulty in extracting spent cartridge cases from the chamber. If this situation occurs, thoroughly clean the chamber with solvent. If this condition persists, we recommend changing to another brand of ammunition.

NOTE: Smith & Wesson® has found that some 22 WMR ammunition has difficulty extracting when the M&P® 22 MAGNUM pistol gets hot, as during extended rapid-firing. Allowing the pistol to cool after a rapid-firing session should improve cartridge extraction.

AMMUNITION - CONTINUED



WARNING: NEVER USE AMMUNITION OF THE INCORRECT GAUGE OR CALIBER. USING AMMUNITION OF THE INCORRECT GAUGE OR CALIBER MAY CAUSE DAMAGE TO YOUR FIREARM AND POSSIBLE INJURY TO YOU AND TO OTHERS.



WARNING: NEVER APPLY LUBRICANTS OR CLEANER DIRECTLY ONTO AMMUNITION. APPLYING LUBRICANT OR CLEANER TO AMMUNITION CAN CONTAMINATE THE AMMUNITION AND RESULT IN A SQUIB LOAD. A SQUIB LOAD CAN RESULT IN A BORE OBSTRUCTION WHEN THE BULLET BECOMES LODGED IN THE BORE. INJURY OR DEATH TO THE SHOOTER OR BYSTANDERS AND DAMAGE TO PROPERTY COULD RESULT WHEN A SUBSEQUENT ROUND IS FIRED.



WARNING: NEVER USE CARTRIDGES OTHER THAN THOSE DESIGNATED BY THE MARKING ON THE FIREARM. DOING SO CAN RESULT IN DANGEROUSLY HIGH PRESSURES THAT MAY DAMAGE THE FIREARM AND POSSIBLY CAUSE INJURY TO YOURSELF AND OTHERS.



WARNING: DEATH, INJURY, AND/OR PROPERTY DAMAGE CAN RESULT FROM THE USE OF INCORRECT AMMUNITION OR BORE OBSTRUCTIONS.

NOTES REGARDING 22 WMR AMMUNITION:

- One of the benefits of the TEMPO™ barrel system is that it generally allows the shooter to use ammunition with “lighter” bullets and still enjoy reliable function of the semi-auto firearm mechanism.
- Smith & Wesson® wants to emphasize that jacketed bullets MUST be used in the M&P® 22 MAGNUM pistol. Ammunition with copper-plated, or polymer-coated bullets will cause reliability issues.
- If non-jacketed ammunition is fired, the clearance between the barrel and barrel shroud quickly becomes leaded and fouled and the gun will not function until it is cleaned thoroughly (see page 39).
- As long as bullets with Full-metal Jacket (FMJ), Total-metal Jacket (TMJ), Jacketed Hollow-point (JHP), Jacketed Soft-point (JSP), or jacketed bullets with a polymer tip like the Hornady® V-Max®, the pistol should function reliably with normal cleaning (see page 39).
- Birdshot loads WILL NOT reliably function in the M&P® 22 MAGNUM.
- Smith & Wesson® has found wide variations in primer sensitivity between different brands and types of 22 WMR ammunition. Smith & Wesson® recommends that before you put your M&P® 22 MAGNUM handgun into regular use, that you fire several boxes of your brand of ammunition through it to determine reliability of ignition. If “failure to fire” occurs, try different types or brands of 22 WMR ammunition until a loading is found that provides reliable function in your pistol.

MODEL & FEATURES IDENTIFICATION

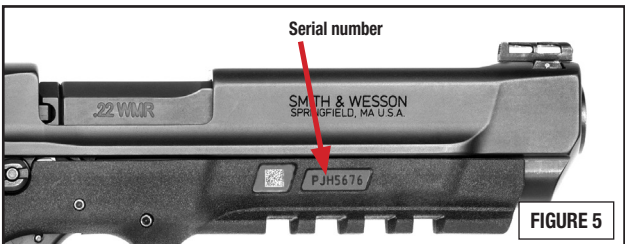
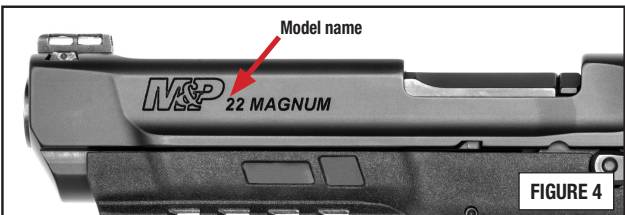
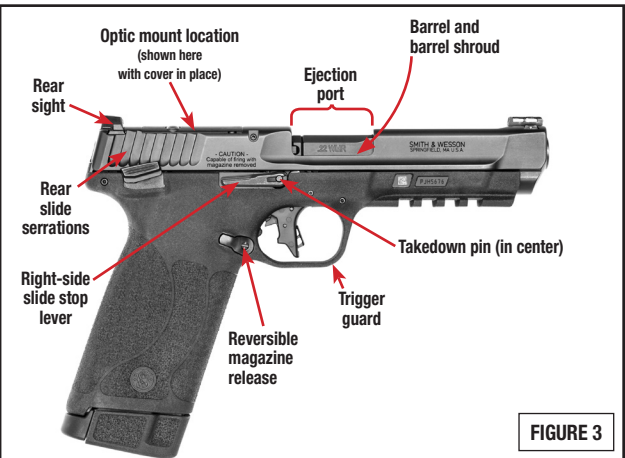
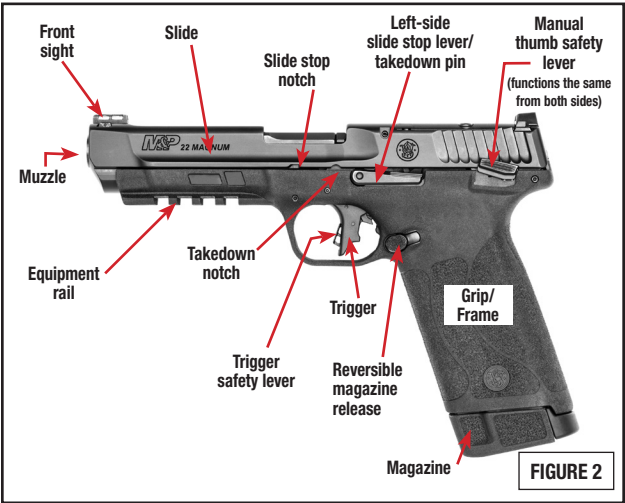

MANUAL THUMB SAFETY LEVER

- Your M&P® 22 MAGNUM pistol is equipped with a manual thumb safety lever. This safety lever functions the same from both the right and left side.



WARNING: NEVER RELY ON MECHANICAL FEATURES ALONE. ONLY YOUR SAFE GUN HANDLING WILL ENSURE THE SAFE USE OF YOUR FIREARM. THIS IS YOUR RESPONSIBILITY.



WARNING: IT IS YOUR RESPONSIBILITY TO CONTINUOUSLY EXAMINE YOUR PERSONAL SITUATION TO PROVIDE A SUFFICIENT LEVEL OF SAFETY.

- This feature prevents the pistol from firing when the manual thumb safety lever is fully up in the “SAFE” position (FIGURE 6).
- Push the thumb safety lever fully down to put it in the “FIRE” position (FIGURE 7). This will allow the pistol to be fired by pulling the trigger fully rearward.



- The magazine can be removed and installed in the pistol regardless of the position of the safety lever.
- The slide can be manipulated to load (or unload) the chamber regardless of the position of the manual thumb safety lever.
- The slide can also be removed from the frame and reinstalled onto the frame regardless of the position of the manual thumb safety lever.
- The safety lever can be moved into the “SAFE” position with the hammer cocked or uncocked.
- Do not load the pistol until you are ready to use it. Keep your finger off the trigger and outside the trigger guard until you are ready to fire.

INSPECTING YOUR PISTOL



WARNING: ALWAYS ENSURE THAT THE PISTOL IS UNLOADED BEFORE INSPECTING, DISASSEMBLING, ASSEMBLING OR CLEANING AND ALWAYS KEEP THE MUZZLE POINTED IN A SAFE DIRECTION.



WARNING: NEVER RELY ON MECHANICAL FEATURES ALONE. ONLY YOUR SAFE GUN HANDLING WILL ENSURE THE SAFE USE OF YOUR FIREARM. THIS IS YOUR RESPONSIBILITY.

- When you inspect your pistol, you must first check for yourself to ensure that it is unloaded. Never take anyone's word for it.

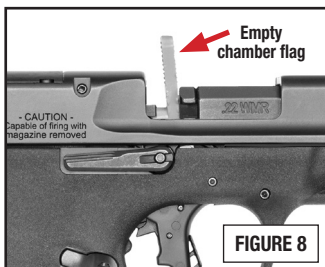

- As shipped from the factory, an empty chamber flag is used to indicate that no round of ammunition is present in the chamber (FIGURE 8).

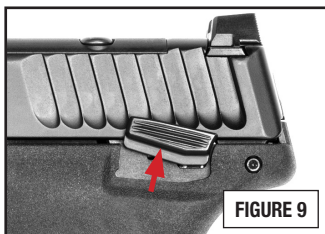

- Grasp the pistol with your finger off the trigger and outside the trigger guard, point the muzzle in a safe direction, press the manual safety lever fully up into the "SAFE" position (FIGURE 9).

- Depress the magazine release and remove the magazine from the pistol (FIGURE 10).

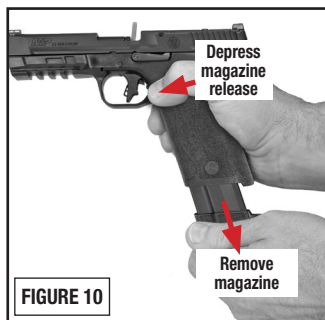

- Grasp the rear slide serrations with the thumb and fingers and briskly draw the slide fully rearward. With the slide still held fully open, lock the slide in the open position by allowing the slide to move slightly forward from the rearmost position while pressing upward on the slide stop lever (FIGURE 11).



WARNING: THE M&P® 22 MAGNUM PISTOL CAN BE FIRED WHEN THE MAGAZINE IS REMOVED FROM THE PISTOL. KEEP YOUR FINGER OFF THE TRIGGER AND OUTSIDE OF THE TRIGGER GUARD UNTIL YOU HAVE MADE THE COMMITMENT TO FIRE.

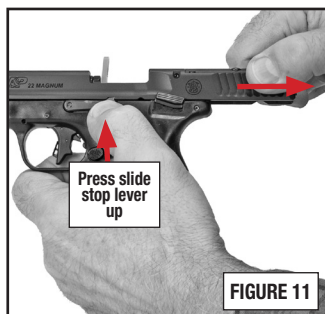

INSPECTING YOUR PISTOL - CONTINUED

- Remove the empty chamber flag from the pistol (FIGURE 12).
- Before using your firearm for the first time, it should be cleaned. See Cleaning and Maintenance section of this manual for details (page 39).
- Check the barrel chamber (FIGURE 13) and magazine well (FIGURE 14) to ensure that no ammunition is present.
- Check the barrel bore for any obstructions. Remove any obstructions that are found.
- Examine the breech face (FIGURE 15a) to ensure that the firing pin is not protruding from the breech face (FIGURE 15b). If the firing pin is protruding (FIGURE 15c), do not attempt to load or fire the firearm. Bring the firearm to a gunsmith qualified to perform service on Smith & Wesson® firearms.

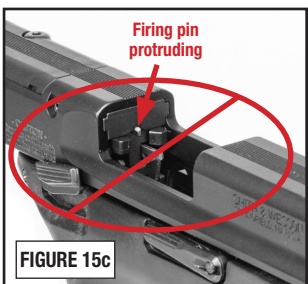
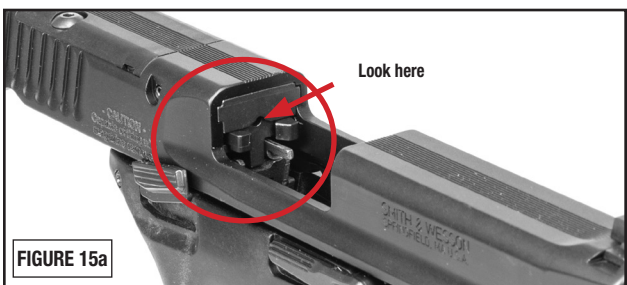
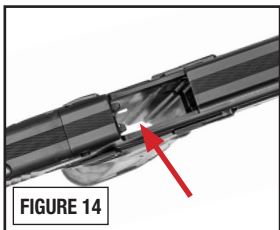
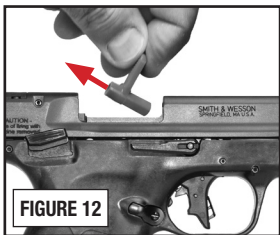

- You must follow this procedure every time a firearm leaves your hand, is cleaned, handed to you or another person, transported, or stored.

PREPARATION FOR FIRING



WARNING: ALWAYS KEEP THE MUZZLE OF THE PISTOL POINT-ED IN A SAFE DIRECTION.



WARNING: FAILURE TO FOLLOW THESE FIREARM SAFETY REQUIREMENTS MAY RESULT IN PERSONAL INJURY OR DEATH TO YOU OR OTHERS AND DAMAGE TO PROPERTY.

- **ALWAYS TREAT ALL FIREARMS AS IF THEY ARE LOADED.**
- **ALWAYS BE SURE THAT THE CHAMBER IS CLEAR OF A CARTRIDGE, THE MAGAZINE IS REMOVED OR UNLOADED, AND THAT THE FIREARM IS POINTING IN A SAFE DIRECTION.**
- **ALWAYS KEEP FINGERS AND OTHER PARTS OF YOUR BODY AWAY FROM THE MUZZLE AND AWAY FROM THE PISTOL SLIDE AND EJECTION PORT.**
- **ALWAYS WEAR ADEQUATE AND PROPER HEARING PROTECTION SPECIFIED FOR FIREARM USE.** To prevent permanent damage to your hearing, you must always use hearing protection. Make sure others who are nearby are wearing hearing protection as well.
- **ALWAYS WEAR SAFETY GLASSES SPECIFIED FOR FIREARM USE.** Whether indoors or out, safety glasses should protect your eyes from the firing flash and particles associated with the discharge of ammunition. Failure to do so creates a risk of personal injury from particle or debris spitting or a ricochet.
- **ALWAYS BE ALERT AND ALWAYS FOLLOW THE SAFETY INSTRUCTIONS OF THE RANGE OFFICER.** Never shoot if you are tired, cold, or otherwise impaired in any way.
- **ALWAYS BE AWARE OF OTHER PEOPLE.** Be aware of others to ensure that persons do not accidentally walk into the line of fire.
- **THE SHOOTER (AND ALL OTHERS IN THE SHOOTING AREA) MUST ALWAYS BE IN A POSITION THAT IS OUT OF THE LINE OF FIRE AND NOT WITHIN AN AREA WHERE THEY MAY BE STRUCK BY A RICOCHET, OR PARTICLES SPITTING FROM A FIREARM, OR BY EJECTED CASES FROM THE FIREARM.**
- **NEVER SHOOT AT SURFACES THAT MAY CAUSE A RICOCHET.** Always select a place to shoot that has a safe backstop, is free from obstructions, and has no surfaces which may cause a ricochet.
- **NEVER FIRE RANDOMLY INTO THE SKY.** Always select a place to shoot that has a safe backstop.
- **NEVER USE ALCOHOL OR DRUGS BEFORE OR WHILE SHOOTING OR HANDLING ANY FIREARM.**

LOADING



WARNING: ALWAYS KEEP THE MUZZLE OF THE PISTOL POINT-ED IN A SAFE DIRECTION.

- Do not load the pistol until you have fully read and understand this manual.
- Do not load the pistol until you are ready to use it. Keep your finger off the trigger and outside the trigger guard until you are ready to fire.
- Never load your pistol until you are sure of your target, what is beyond it, and are fully prepared to fire.
- Smith & Wesson® has provided you with a magazine designed to operate in your specific model of pistol. While your magazine may be able to be inserted into another pistol model, it will only function properly in the specific model for which it was designed. Do not interchange magazines from one model pistol to another model of pistol.
- Load the magazine by pressing each cartridge down and back into the magazine (FIGURES 16a and 16b). The cartridges will alternate from side to side as they are loaded. It is important that the cartridges are pushed into the correct side. Ensure the rim of the cartridge being loaded is always in front of the round below it (FIGURE 16c). The magazine will not properly feed a cartridge if the cartridge rims are not in correct position. If the top cartridge rim is not in front, remove cartridge and re-insert, verifying correct position. Repeat this procedure for the number of cartridges you wish to load, up to the magazine capacity. Do not attempt to load your magazine with more than the specified number of cartridges because doing so can cause a failure to feed.

Insert cartridge rim under the narrow part of magazine lips.

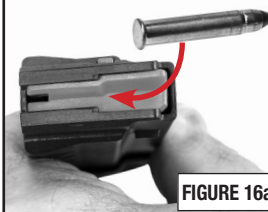

Press cartridge down and back into the magazine, the cartridges will alternate from side to side as they are loaded.

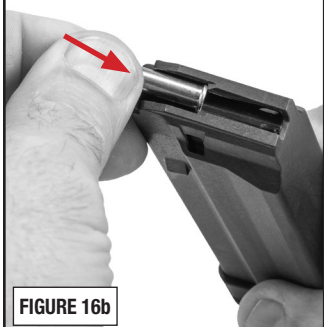

Keep rim of top cartridge in front of the one below it.

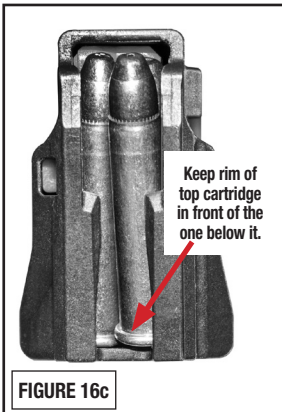

LOADING - CONTINUED

- With the muzzle pointing in a safe direction and with your finger off the trigger and outside the trigger guard, insert the loaded magazine into the magazine well (opening) of the pistol until it is locked in place (FIGURE 17).



WARNING: DO NOT USE EXCESSIVE UPWARD FORCE WHEN INSERTING

A LOADED MAGAZINE INTO THE PISTOL. EXCESSIVE UPWARD FORCE COULD CAUSE THE SLIDE TO MOVE FORWARD, CHAMBERING A ROUND AND MAKING THE PISTOL READY TO FIRE.



FIGURE 17

NOTE: After inserting a magazine, test to make sure it is locked in place by applying some removal pressure to the exposed portion of the magazine butt plate.

- Pull the slide to the rear (FIGURE 18) and release it, allowing it to carry fully forward. This strips a cartridge from the magazine and seats it in the chamber of the barrel.

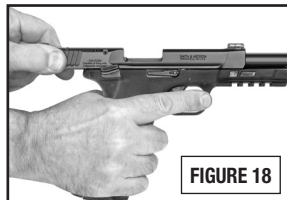

FIGURE 18



WARNING: IF THE CARTRIDGE FAILS TO STRIP FROM THE MAGAZINE OR FULLY SEAT INTO THE CHAMBER, IMMEDIATELY STOP THE LOADING PROCESS. REMOVE THE MAGAZINE, LOCK THE SLIDE OPEN AND VERIFY THAT THE CHAMBER IS EMPTY. REFER TO THE "INSPECTING YOUR PISTOL" SECTION OF THIS MANUAL (PAGE 14) AND THE "CLEARING A MISFEED/JAM" SECTION (PAGE 22).



WARNING: ALWAYS LOAD A ROUND INTO THE CHAMBER BY FEEDING IT FROM THE MAGAZINE. NEVER ATTEMPT TO LOAD THE PISTOL BY INSERTING A ROUND INTO THE OPEN EJECTION PORT. FAILURE TO FOLLOW THIS WARNING CAN RESULT IN INJURY OR DEATH TO YOU OR OTHERS AND DAMAGE TO PROPERTY.

CAUTION: The pistol can now be fired by pulling the trigger fully to the rear (when the manual safety is placed in the "FIRE" position).

- If you wish to restore the magazine in your pistol to its full capacity, depress the magazine release and remove the magazine from the pistol. Remember that there is a round in the chamber; therefore, the weapon should be holstered or safely secured during this process without touching the trigger. Load a cartridge into the magazine to replace the one that was chambered when you allowed the slide to close and chamber a round.

LOADING - CONTINUED

- Reinsert the loaded magazine into the magazine well of the pistol until it is locked in place (FIGURE 19). Make sure that the magazine is inserted securely by applying some removal pressure to the exposed portion of the magazine butt plate.

CAUTION: The pistol can now be fired by pulling the trigger fully to the rear (when the manual safety has been placed in the “FIRE” position).



- Keep your pistol pointed in a safe direction under all conditions and always keep your finger or any other object off the trigger and outside the trigger guard until you have made the commitment to fire the handgun.
- Never leave a loaded firearm out of your direct control.

FIRING



WARNING: ALWAYS KEEP THE MUZZLE OF THE PISTOL POINTED IN A SAFE DIRECTION.



WARNING: UPON FIRING THE PISTOL OR RELEASING THE SLIDE FROM THE SLIDE STOP, THE SLIDE MOVES REARWARD OR FORWARD WITH SIGNIFICANT FORCE AND SPEED. TO AVOID INJURY, BE SURE NO PART OF YOUR BODY IS IN THE PATH OF THE SLIDE'S TRAVEL (FIGURE 20).



WARNING: WEAR EYE AND HEARING PROTECTION SPECIFIED FOR FIREARM USE EVERY TIME YOU DISCHARGE YOUR FIREARM. MAKE SURE OTHERS IN THE VICINITY OF WHERE YOU WILL BE SHOOTING DO SO AS WELL.

FIRING - CONTINUED

- Keep the muzzle of the firearm pointed in a safe direction and your finger outside the trigger guard until you are ready to fire.
- While holding the grip firmly, place the manual safety into the “FIRE” position, aim the pistol and pull the trigger fully to the rear. As the trigger safety lever is depressed and the trigger is pulled fully to the rear (FIGURES 21 and 22), the firing mechanism is cycled, striking the rim of the cartridge and firing the cartridge.
- Upon firing, the slide moves rearward with significant force, extracting and ejecting the spent cartridge case. The slide then returns forward under spring pressure, feeding the next cartridge from the magazine into the barrel chamber.
- After firing a shot, you must allow the trigger to move forward to reset the mechanism before you can fire another shot.



- This sequence can be repeated until the last round has been fired, at which time the magazine follower exerts upward pressure on the slide stop lever causing it to engage the slide and hold the slide in the “open” position.

WARNING: AFTER A SESSION OF RAPID FIRING, MOVE THE SAFETY LEVER TO THE “SAFE” POSITION, REMOVE THE MAGAZINE FROM THE PISTOL, EJECT THE CHAMBERED ROUND (IF ONE IS PRESENT) AND ALLOW THE PISTOL TO COOL. POSITION THE FIREARM TO AVOID BURNS OR HEAT DAMAGE TO OBJECTS.

WARNING: RAPID FIRING WILL CAUSE PARTS OF THE PISTOL TO BECOME VERY HOT. BE CAREFUL NOT TO TOUCH HOT PARTS, AS BURNS MAY RESULT.

NOTE: Smith & Wesson® has found that some 22 WMR ammunition has difficulty extracting when the M&P® 22 MAGNUM pistol gets hot, as during extended rapid-firing. Allowing the pistol to cool after a rapid-firing session should improve cartridge extraction.

- It has come to our attention that some users of Smith & Wesson® handguns may “stage” the trigger in anticipation of firing a shot. Staging is the act of pulling the trigger rearward – stopping just short of – the point where the handgun fires. Such manipulation of the trigger can reduce the user’s control of the handgun and can result in an unintentional discharge.

FIRING - CONTINUED



WARNING: "STAGING" THE TRIGGER VIOLATES A BASIC RULE OF FIREARM SAFETY WHICH WARNS YOU TO KEEP YOUR FINGER OUT OF THE TRIGGER GUARD UNTIL YOU HAVE MADE THE COMMITMENT TO FIRE. "STAGING" CREATES A RISK OF INJURY OR DEATH TO THE SHOOTER AND/OR BYSTANDERS AND DAMAGE TO PROPERTY SINCE IT MAY LEAD TO AN UNINTENTIONAL DISCHARGE.

HANGFIRES AND MISFIRES



WARNING: ALWAYS KEEP THE MUZZLE OF THE PISTOL POINTED IN A SAFE DIRECTION.



WARNING: WEAR EYE AND HEARING PROTECTION SPECIFIED FOR USE WITH FIREARMS WHEN FIRING AND CLEARING MISFIRES OR MISFEEDS.



WARNING: KEEP YOUR FACE A SAFE DISTANCE FROM THE EJECTION PORT WHEN CLEARING A CARTRIDGE. IF A CARTRIDGE IGNITES WHILE BEING CLEARED FROM THE FIREARM, DEATH OR INJURY MAY RESULT.



WARNING: IF YOUR FIREARM GIVES ANY INDICATION THAT IT IS NOT PERFORMING PROPERLY OR THE OPERATION OF YOUR FIREARM HAS CHANGED "THE WAY IT FEELS OR SOUNDS", STOP FIRING. MAKE SURE THE FIREARM IS POINTED IN A SAFE DIRECTION, UNLOAD THE FIREARM AND HAVE IT INSPECTED AND TEST FIRED BY A GUNSMITH QUALIFIED TO PERFORM SERVICES ON SMITH & WESSON® FIREARMS.

NOTE: In the case of either a hangfire or misfire, keep the muzzle pointed in a safe direction and your finger off the trigger. Wait 60 seconds, then, while keeping the muzzle pointed in a safe direction, push the manual thumb safety fully up into the "SAFE" position (FIGURE 23).

- Depress the magazine release and remove the magazine from the pistol (FIGURE 24).
- Proceed to clear the unfired cartridge from the chamber.



HANGFIRES AND MISFIRES - CONTINUED

- A **HANGFIRE** is described as a noticeable delay between the impact of the firing pin on the rim of the cartridge and the actual discharge of the firearm. This is generally caused by defective or damaged ammunition.
- With the firearm pointed in a safe direction, the magazine should be removed and the firearm should be unloaded. The remainder of similar ammunition should be inspected to determine if it has been contaminated or damaged and, if found to be contaminated or damaged, dispose of in a method specifically approved for live round disposal.
- A **MISFIRE** is the failure of the chambered cartridge to fire at all after the trigger has been pulled. This is generally caused by defective or damaged ammunition or a dirty or fouled firearm.
- A light rim/primer strike caused by a dirty or fouled firearm can lead to misfires. If a light indent on the rim of a misfire is noted, unload the firearm and clean it as instructed in the Cleaning and Maintenance section of this manual (page 39). If the cartridge does not go off, the “dud” cartridge needs to be removed from the firearm.
- Move the manual safety lever up into the “SAFE” position (FIGURE 25).
- Pull the slide all the way back to eject the suspect cartridge (FIGURE 26). Hold the slide open.
- Press up on the slide stop lever and let the slide move forward against the slide stop to lock the slide open (FIGURE 27).
- Visually check the chamber (FIGURE 28) and the magazine well (FIGURE 29) to be certain that no cartridges are present.
- The firearm should be inspected and cleaned before returning it to use.
- The ammunition should be inspected and damaged or defective rounds should not be used.

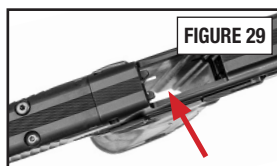
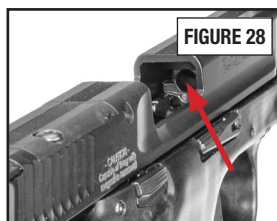
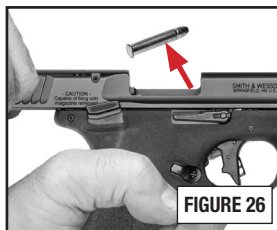
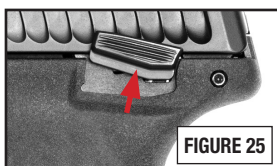

HANGFIRES AND MISFIRES - CONTINUED

- Dispose of defective cartridge(s) in a method specifically approved for live round disposal.



WARNING: THE M&P® 22 MAGNUM PISTOL CAN BE FIRED WHEN THE MAGAZINE IS REMOVED FROM THE PISTOL. KEEP YOUR FINGER OFF THE TRIGGER AND OUTSIDE OF THE TRIGGER GUARD UNTIL YOU HAVE MADE THE COMMITMENT TO FIRE.

CLEARING A MISFEED/JAM

NOTE: Any autoloading firearm may, on occasion, fail to feed a cartridge properly from the magazine and into the chamber. When this occurs, it is referred to as a misfeed or a jam. If this should occur:



WARNING: KEEP YOUR FACE A SAFE DISTANCE FROM THE EJECTION PORT WHEN CLEARING A MISFEED/JAMMED CARTRIDGE. A CARTRIDGE MAY IGNITE IF THE RIM OF THE CARTRIDGE IS STRUCK WITH SUFFICIENT FORCE. IF A CARTRIDGE IGNITES WHILE BEING CLEARED FROM THE FIREARM, DEATH OR INJURY MAY RESULT.



WARNING: ALWAYS KEEP THE MUZZLE OF THE PISTOL POINTED IN A SAFE DIRECTION.

- Press the manual safety lever fully up into the "SAFE" position (FIGURE 30).
- Depress the magazine release and remove the magazine (FIGURE 31).
- Pull the slide fully rearward and engage the slide stop (FIGURE 32) to lock the slide open.

NOTE: Drawing the slide fully to the rear should allow clearance for the jammed cartridge to fall free and clear of the firearm (FIGURE 33).

- It may be necessary to manually remove a jammed cartridge. When attempting to clear a jam manually, use only wooden 'tools', such as a pointed dowel or a pencil, and use extreme care to avoid striking the cartridge rim.



CLEARING A MISFEED/JAM - CONTINUED

- Check to make sure all cartridges have been removed from the firearm.
- Once the misfed cartridge is cleared, proceed to load the firearm as instructed in the LOADING section of this manual (page 16).
- Dispose of defective cartridge(s) in a method specifically approved for live round disposal.

UNLOADING



WARNING: ALWAYS KEEP YOUR PISTOL POINTED IN A SAFE DIRECTION. ALWAYS KEEP YOUR FINGER OFF THE TRIGGER AND OUTSIDE THE TRIGGER GUARD WHEN UNLOADING.



WARNING: THE M&P® 22 MAGNUM PISTOL CAN BE FIRED WHEN THE MAGAZINE IS REMOVED FROM THE PISTOL. KEEP YOUR FINGER OFF THE TRIGGER AND OUTSIDE OF THE TRIGGER GUARD UNTIL YOU HAVE MADE THE COMMITMENT TO FIRE.

- Point the muzzle in a safe direction. Make sure your finger is off the trigger and out of the trigger guard. Depress the magazine release and remove the magazine (FIGURE 34).



FIGURE 34

- Keep the muzzle pointed in a safe direction, and keep your finger off the trigger and outside the trigger guard, grasp the serrated sides of the slide from the rear with the thumb and fingers, and briskly draw the slide fully rearward in order to extract any cartridge from the barrel chamber and clear it from the pistol (FIGURE 35).



FIGURE 35

- Lock the slide in the open position by allowing the slide to move slightly forward from the rearmost position while pressing upward on the slide stop lever (FIGURE 36).

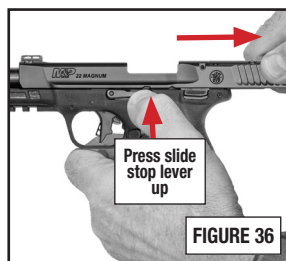
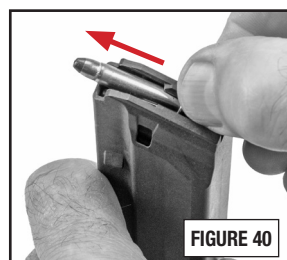
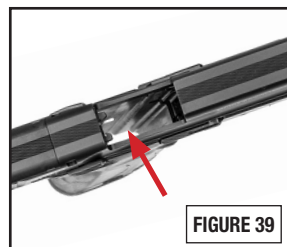
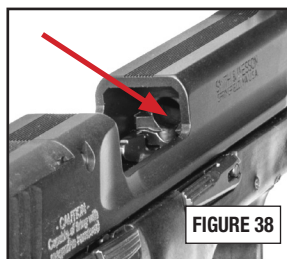
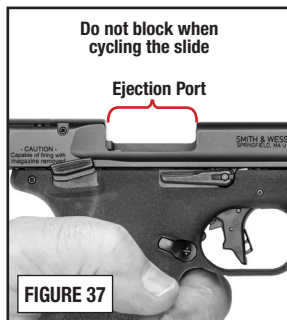

FIGURE 36

UNLOADING - CONTINUED

- Do not obstruct the ejection port when pulling the slide to the rear because doing so can interfere with ejection of a cartridge (FIGURE 37).
- Look into the chamber (FIGURE 38) and down through the magazine well (FIGURE 39). Verify that no ammunition remains in the pistol.
- Unload the magazine by holding it with the bullet end of the cartridge pointing away from you and pressing each cartridge forward and out of the magazine (FIGURE 40). A blunt tool like a wooden dowel or plastic pen works to help with this.



FIELD STRIPPING/DISASSEMBLY



WARNING: ALWAYS KEEP YOUR PISTOL POINTED IN A SAFE DIRECTION. ALWAYS KEEP YOUR FINGER OFF THE TRIGGER AND OUTSIDE THE TRIGGER GUARD WHEN DISASSEMBLING.



WARNING: ALWAYS FOLLOW THESE INSTRUCTIONS EXACTLY. NEVER DO ANYTHING BEYOND WHAT YOU ARE SPECIFICALLY INSTRUCTED TO DO IN THIS SAFETY & INSTRUCTION MANUAL.



WARNING: WEAR SAFETY GLASSES EVERY TIME YOU DISASSEMBLE OR ASSEMBLE YOUR FIREARM.



WARNING: DO NOT ALTER, MODIFY OR REPLACE ANY OF THE PARTS OF YOUR FIREARM UNLESS THIS WORK IS PERFORMED BY A QUALIFIED GUNSMITH USING GENUINE SMITH & WESSON® PARTS. IF YOU DO OTHERWISE, IMPROPER FUNCTIONING MAY OCCUR AND INJURY OR DEATH MAY RESULT.

NOTE REGARDING DISASSEMBLY PROCEDURE: The hammer of the M&P® 22 MAGNUM must be in the “cocked” position prior to attempting to remove the slide. Place the safety into the “SAFE” position. Remove the magazine from the pistol. Grasp the slide and draw it fully rearward to eject any shell that may have been chambered. In the process of doing this, the hammer will move to the “cocked” position and disassembly can begin.

- Place the manual thumb safety lever up in the “SAFE” position (FIGURE 41).
- Depress the magazine release and remove the magazine (FIGURE 42).
- With the muzzle pointing in a safe direction, and with your finger off the trigger and outside the trigger guard, grasp the serrated sides of the slide from the rear with the thumb and fingers while holding the firearm in an upright position, briskly draw the slide fully rearward in order to extract any cartridge from the barrel chamber and clear it from the pistol (FIGURE 43).



FIGURE 41

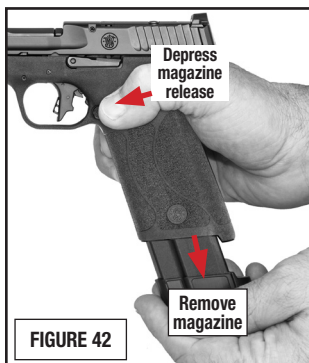

FIGURE 42



FIGURE 43

FIELD STRIPPING / DISASSEMBLY - CONTINUED

- Lock the slide open by holding it fully rearward and pressing up on the slide stop lever (FIGURE 44).
- Make certain that the chamber is empty (FIGURE 45).
- Make certain that the magazine well is clear of any ammunition (FIGURE 46).

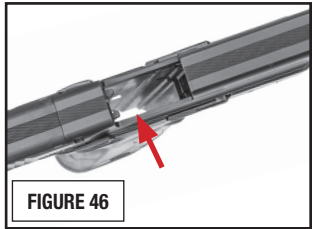
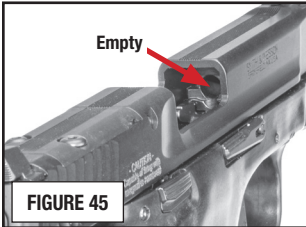

- Locate the Slide stop lever/Takedown pin on the right side of the pistol (as viewed from the rear) (FIGURE 47).



- Close the slide by grasping the serrated sides and drawing it rearward (FIGURE 48), until the slide stop disengages, then allow the slide to move forward to its closed position.



FIELD STRIPPING / DISASSEMBLY - CONTINUED

- (FIGURE 49) and (FIGURE 50) are closeup views that show the takedown notch in the slide and the raised part of the Slide stop lever/Takedown pin that need to be aligned.
- Grasp the slide and push it back about $\frac{1}{4}$ " (FIGURE 51).

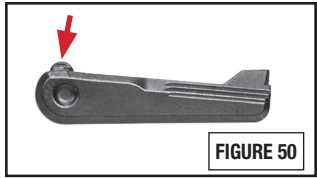
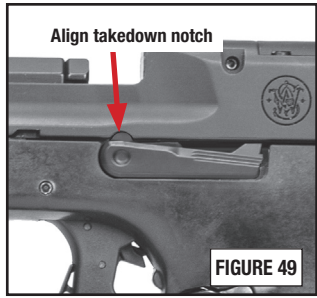

- While holding the slide with the takedown notch aligned, use a small punch or drift to push the Slide stop lever/Takedown pin out of position from the right side (FIGURES 52 and 53).

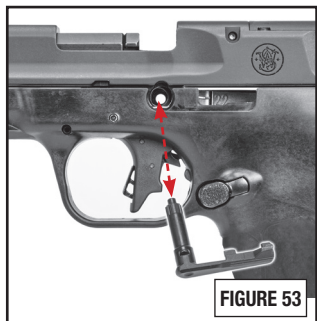
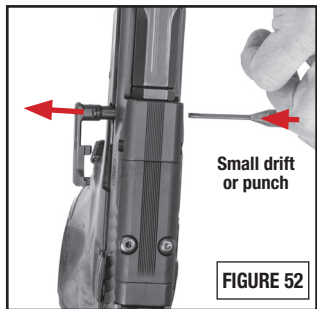

FIELD STRIPPING / DISASSEMBLY - CONTINUED

- Once the Slide stop lever/Takedown pin is removed, loosen your grasp on the slide and remove the slide from the frame by pushing/pulling it forward (FIGURE 54). Retain control of the recoil spring when the slide is removed from the frame.



- (FIGURE 55) shows the recoil spring assembly in relation to the barrel shroud lug and slide.
- Remove the recoil spring assembly from the slide by compressing the spring slightly and lifting it up and out (FIGURE 56).
- Remove the barrel and barrel shroud as a unit from the slide by grasping the two parts by the barrel shroud lug and lifting up and back (FIGURE 57).



- (FIGURE 59) shows the M&P® 22 MAGNUM barrel and barrel shroud being separated.



FIELD STRIPPING / DISASSEMBLY - CONTINUED

- (FIGURE 60) shows the M&P® 22 MAGNUM barrel completely removed from the barrel shroud.

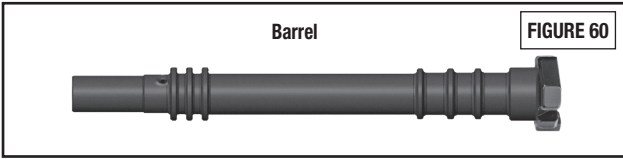

- (FIGURE 61) shows the M&P® 22 MAGNUM barrel shroud - ready for cleaning.

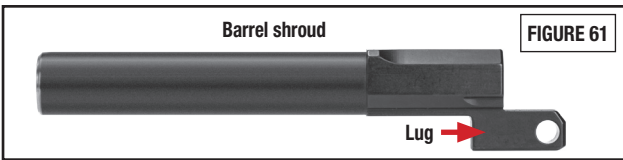

WARNING: NEVER DISASSEMBLE YOUR FIREARM BEYOND THE FIELD STRIPPING PROCESS OUTLINED IN THIS MANUAL. NEVER MANIPULATE ANY INTERNAL COMPONENTS BEYOND WHAT YOU ARE SPECIFICALLY INSTRUCTED TO DO IN THIS MANUAL SINCE THIS MAY AFFECT THE RELIABILITY, FUNCTIONING AND SAFETY OF YOUR HANDGUN.

WARNING: DO NOT DRY-FIRE THE M&P® 22 MAGNUM PISTOL. DOING SO CAN RESULT IN DAMAGE TO THE PISTOL.

- (FIGURE 62) shows the M&P® 22 MAGNUM pistol field-stripped for cleaning.

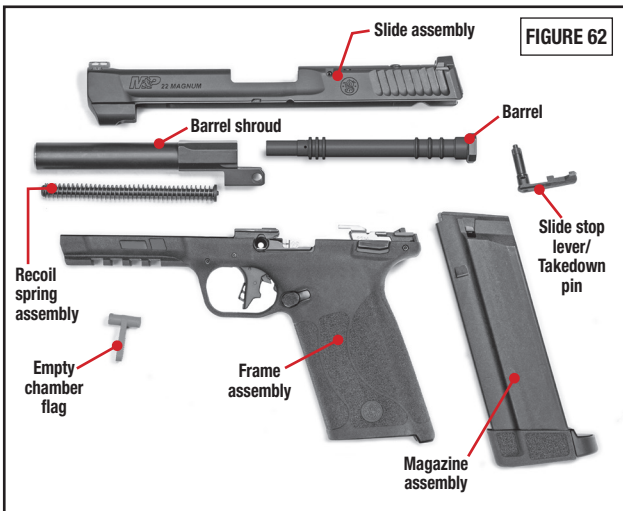

LUBRICATION

- There are eight lubrication points (FIGURES 63 and 64) where a single drop of high-quality firearm lubricant should be applied. This will ensure proper lubrication.

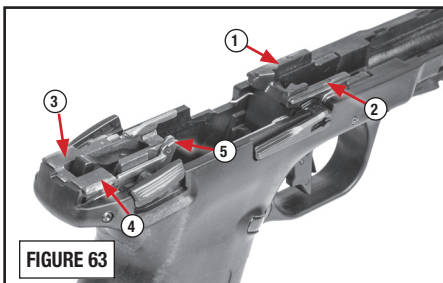

FIGURE 63

Care should be taken not to over-lubricate the pistol. Excess lubricant can collect large quantities of unburned powder and carbon residue, which could interfere with proper functioning of the pistol.

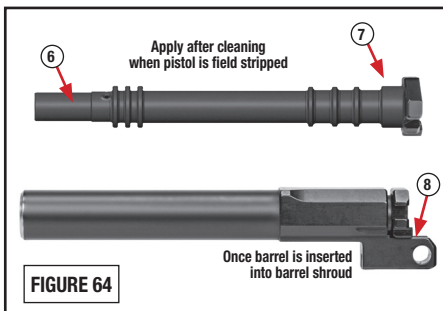

FIGURE 64

ASSEMBLY



WARNING: ALWAYS FOLLOW THESE INSTRUCTIONS EXACTLY. NEVER DO ANYTHING BEYOND WHAT YOU ARE SPECIFICALLY INSTRUCTED TO DO IN THIS SAFETY & INSTRUCTION MANUAL. NEVER ALTER OR MODIFY THE PARTS IN YOUR PISTOL.



WARNING: WEAR SAFETY GLASSES EVERY TIME YOU DISASSEMBLE OR ASSEMBLE YOUR FIREARM.

- Replace the barrel into the barrel shroud as shown (FIGURES 65 and 66).

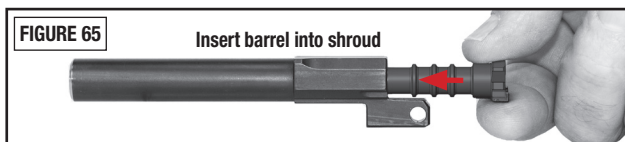

FIGURE 65



FIGURE 66

ASSEMBLY - CONTINUED

- Replace the barrel assembly into the slide as shown (FIGURE 67). Start the muzzle end into the hole at the front of the slide and then tip the rear of the barrel assembly down into position.

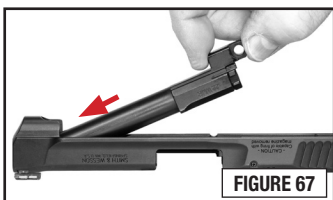

- Install the recoil spring assembly (FIGURES 68 and 69), align the base of the spring assembly against the barrel shroud lug (FIGURE 70).

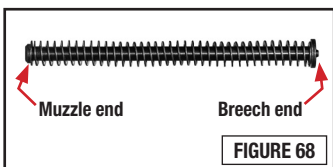

- Seat the recoil spring/guide rod so it is centered on the barrel shroud lug (FIGURE 71).

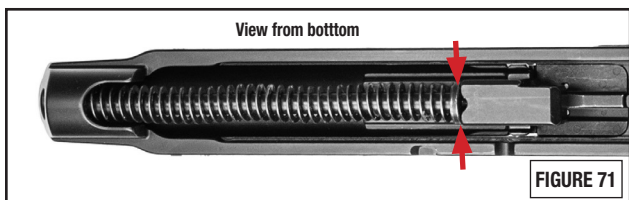
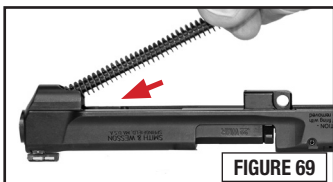

NOTE: Make sure that the hammer is in the “cocked” position. If the hammer is in the “fired” position, it will stick up above the frame (FIGURE 72), push it down and back until it is cocked as shown (FIGURE 73).

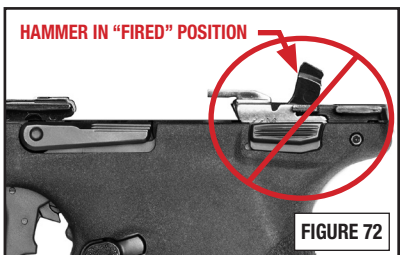

ASSEMBLY - CONTINUED

- While retaining the recoil spring in position, push the slide assembly onto the front frame rails (FIGURE 74).



- Continue to push the slide back and onto the rear frame rails (FIGURE 75).

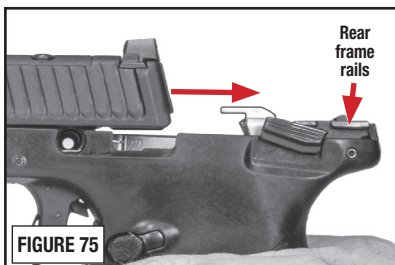

- Pull the slide rearward until the takedown notch in the slide aligns with the hole in the frame (FIGURE 76) and hold it there.

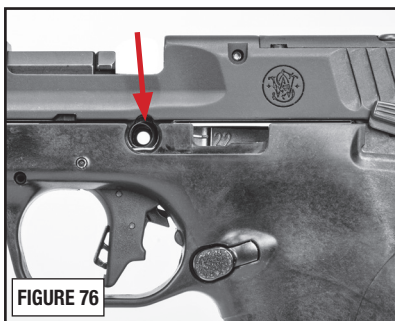

- (FIGURES 77 and 78) are closeup views that show the takedown notch in the slide and the raised part of the Slide stop lever/Takedown pin that need to be aligned when reassembling.

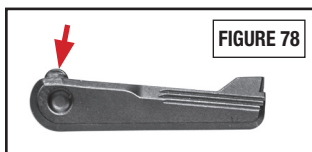
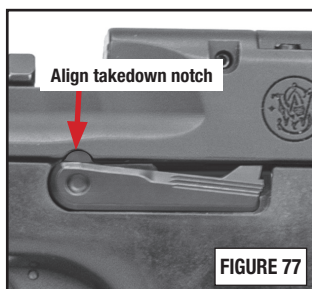

ASSEMBLY - CONTINUED

- With the slide held back on the frame about 1/4" (FIGURE 79), insert the Slide stop lever/Takedown pin until it "clicks" into place (FIGURE 80).



- Release your grasp and allow the slide to move forward to its closed position.
- Grasp the rear slide serrations and draw the slide rearward to confirm that it is installed correctly and moving freely (FIGURE 81).

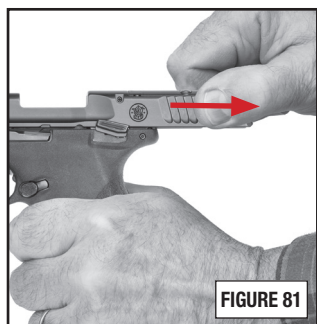
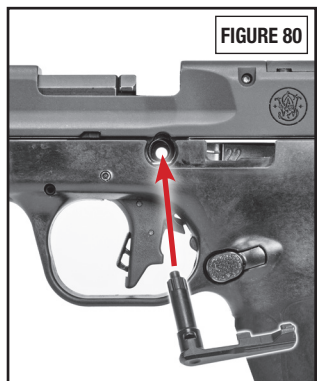

MAGAZINE FOR M&P® 22 MAGNUM



WARNING: WEAR SAFETY GLASSES EVERY TIME YOU DISASSEMBLE OR ASSEMBLE YOUR MAGAZINE.



WARNING: THE MAGAZINE SPRING IS UNDER PRESSURE IN THE ASSEMBLED MAGAZINE. WHEN DISASSEMBLING OR ASSEMBLING THE MAGAZINE, CONTROL THE MOVEMENT OF THE SPRING AND OTHER PARTS OF THE MAGAZINE SO THEY DO NOT FLY OUT AND CAUSE INJURY.

MAGAZINE DISASSEMBLY

- (FIGURE 82) shows the M&P® 22 MAGNUM factory magazine.
- Using a small diameter tool like a punch or drift, depress floor plate catch through the hole in the floor plate at the bottom of the magazine. Allow the floor plate to move just enough to keep the catch depressed (FIGURE 83).
- While holding floor plate catch in the tube against spring pressure, slide floor plate forward and off the magazine tube (FIGURE 84).
- (FIGURE 85) shows the magazine spring and floor plate catch once the floor plate has been removed.
- Remove floor plate catch, the spring, and follower out through bottom of tube.



FIGURE 82

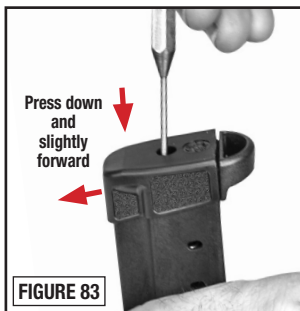

FIGURE 83

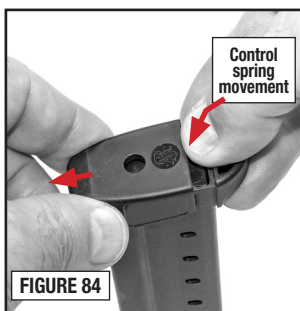

FIGURE 84

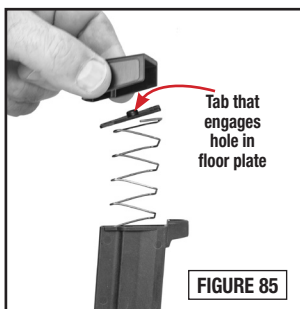
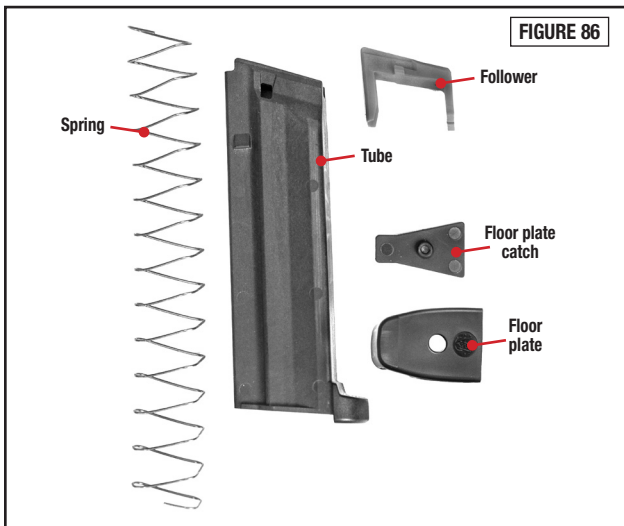

FIGURE 85

MAGAZINE FOR M&P® 22 MAGNUM - CONTINUED

- (FIGURE 86) shows the parts of the disassembled magazine.



MAGAZINE ASSEMBLY

- Install the follower, the spring, and floor plate catch into the tube.

NOTE: The magazine spring is directional. It only works correctly when installed with the narrow end at the top, with the slope of the spring against the follower (FIGURE 87).

- Place the floor plate catch on top of the spring and push the spring down until the floor plate can be slid into position on the tube.
- Depress the floor plate catch slightly and continue to slide the floor plate fully onto the tube.
- Apply some forward removal pressure on the floor plate to confirm that it is “locked” into position, taking care not to pull the floor plate entirely off and ejecting the spring and floorplate catch.

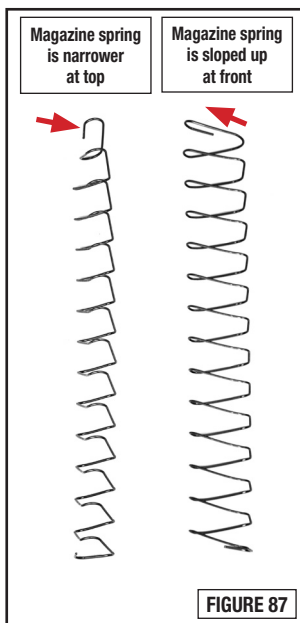

REVERSIBLE MAGAZINE RELEASE

NOTE: The magazine release can be installed to operate from the right or left side. To reverse the magazine release, follow these instructions:



WARNING: ALWAYS KEEP THE MUZZLE OF THE PISTOL POINTED IN A SAFE DIRECTION.



WARNING: ENSURE THAT YOUR FIREARM IS UNLOADED BEFORE BEGINNING TO DISASSEMBLE IT.



WARNING: WEAR SAFETY GLASSES EVERY TIME YOU DISASSEMBLE OR ASSEMBLE YOUR FIREARM AND ATTEMPT CLEANING, MAINTENANCE OR ADJUSTMENT.

- (FIGURE 88) shows the magazine release plunger's location while in the pistol.
- (FIGURE 89) shows the magazine release removed from the pistol for clarity.
- Press the magazine release and remove the magazine from the pistol.
- When installing the magazine release, the textured side (FIGURE 90) should be on the side of the pistol that you want to push on to release the magazine from the pistol.
- A small screwdriver is used to depress the locking screw (a small amount of force is all that is required) and turn it (FIGURE 91).

NOTE: When switching sides of operation of the magazine release, the textured side must be inserted into the frame opening first.

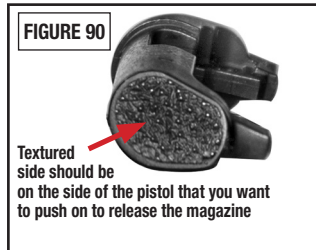
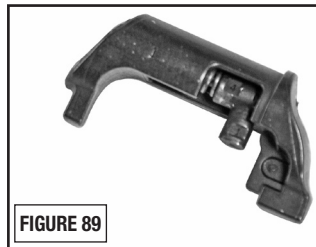
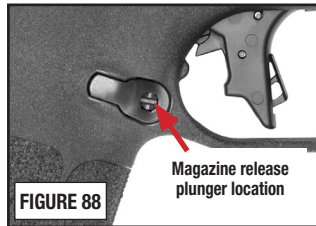

REVERSIBLE MAGAZINE RELEASE - CONTINUED

NOTE: The magazine release plunger only needs to be pushed in slightly (using a small screwdriver) in order to turn it - for either unlocking it - or locking it back into the frame. Follow the guidelines in (FIGURE 92) to remove and install the magazine release. One-quarter turn is all that is required, in either direction, to unlock and lock.

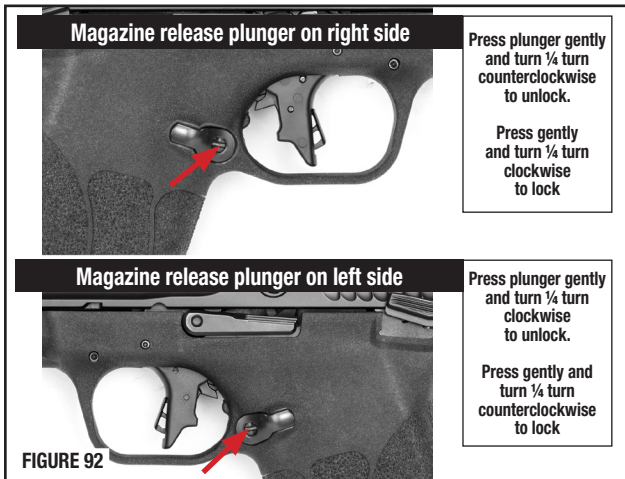

- Once the magazine release is installed, insert an unloaded magazine into the pistol and check the magazine release for proper function.

NOTE: If the magazine release plunger is pressed too hard or turned too far, it may become disassembled. Reassemble the parts (FIGURE 93) before inserting the magazine release back into the pistol. A pair of needlenose pliers may help in the assembly process.

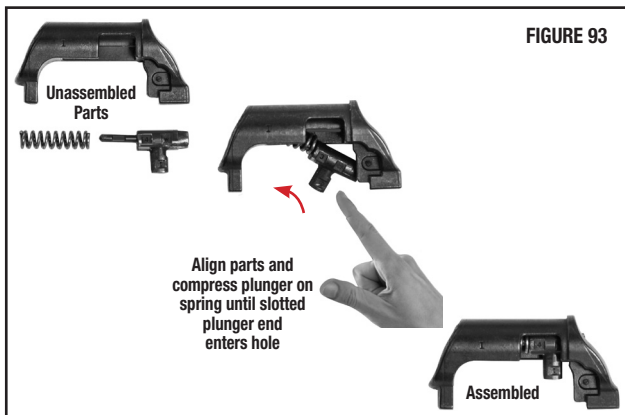

WARNING: THE MAGAZINE RELEASE PLUNGER SPRING IS UNDER PRESSURE IN THE ASSEMBLED MAGAZINE RELEASE. WHEN DISASSEMBLING OR ASSEMBLING, CONTROL THE SPRING SO IT DOESN'T FLY OUT AND CAUSE INJURY.

REAR SIGHT ADJUSTMENT



WARNING: ENSURE THAT YOUR PISTOL AND MAGAZINE ARE COMPLETELY UNLOADED BEFORE ATTEMPTING TO ADJUST THE REAR SIGHT.

- The rear sight is adjustable for windage only. Windage is the side to side adjustment of where your bullet hits on target - in relation to where you are aiming.
- To adjust windage, move the rear sight in the direction you wish the group to move on the target. For example, if the group should move to the right, move the rear sight to the right.
- The rear sight is secured in position with a hex screw that uses a 5/64" hex wrench.
- Loosen the lock screw slightly (FIGURE 94) to allow the rear sight to be moved in the desired direction. A plastic or brass drift and small hammer may be required to move the sight in the desired direction.
- Tighten the lock screw once the sight is in its new position.

FIGURE 94

After loosening lock screw, move the rear sight left to make bullet strikes move left on target



Move rear sight right to make bullet strikes move right on target

CLEANING AND MAINTENANCE



WARNING: ENSURE THAT THE PISTOL IS UNLOADED BEFORE BEGINNING TO CLEAN IT. ALWAYS KEEP THE MUZZLE OF THE PISTOL POINTED IN A SAFE DIRECTION.



WARNING: WEAR SAFETY GLASSES EVERY TIME YOU DISASSEMBLE OR ASSEMBLE YOUR FIREARM AND ATTEMPT CLEANING OR MAINTENANCE.

- Before using your firearm for the first time, it should be cleaned.
- Your firearm was treated at the factory with either a preservative or oil to protect it against corrosion during shipping and storage.
- Preservative and oil should be wiped from the bore, chamber and exposed areas using a clean swab or patch before using the firearm.

CAUTION: Never disassemble your firearm beyond the instructions in the Field Stripping/Disassembly section of this manual (page 25).

- Purchase cleaning supplies from your firearms dealer that are specifically designated for your type and caliber of firearm. Many suppliers offer these in kit form for your convenience.

NOTE: A basic firearm cleaning kit should include: a brass bore brush and a cleaning jag of appropriate size for the bore being cleaned, high-quality gun cleaning solvent and gun oil/lubricant, cotton cleaning patches and a cleaning rod that is long enough to push the brush and jag completely through the barrel from the breech toward the muzzle.

M&P® 22 MAGNUM BARREL/BARREL SHROUD CLEANING/MAINTENANCE

- We recommend that the barrel/barrel shroud be removed from the firearm every 500 rounds at a minimum, and its surfaces cleaned.
- Remove the barrel from the pistol by following the instructions detailed in the Field Stripping/Disassembly section of this manual (page 25).

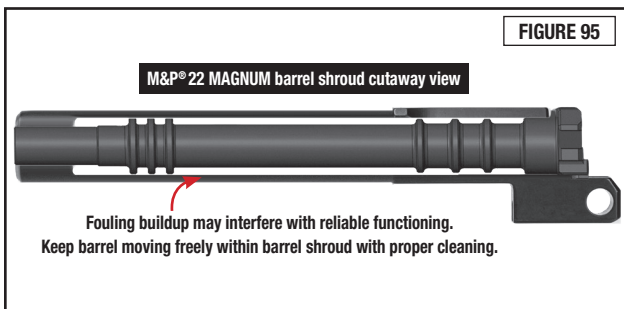

CLEANING AND MAINTENANCE - CONTINUED

- Fill a container that will hold the barrel and barrel shroud with CLP (Cleaner - Lubricant - Preservative) and let the barrel and barrel shroud soak for several hours.
- Using brushes, picks, and CLP, remove carbon and residue from the external surfaces of the barrel and the internal surfaces of the barrel shroud.
- Use non-marring tools on all surfaces to avoid damaging the finish.
- Clean fouling from all surfaces and the barrel gas port (FIGURE 96).

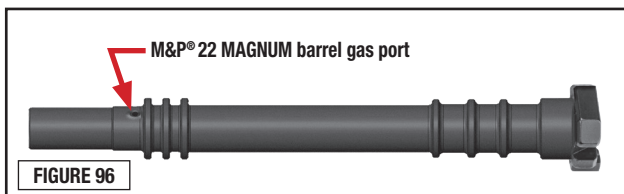

- Wipe all surfaces with a clean rag to remove debris and excess CLP.
- Clean the exterior of the firearm using a non-abrasive cleaning cloth.
- After cleaning, lightly coat the metal parts, internal and external with a high quality gun oil.
- Whenever your firearm has been exposed to sand, dust, extreme humidity, water or other adverse conditions, it must be cleaned and lubricated in accordance with the processes provided in this Safety & Instruction Manual.

WARNING: ALWAYS HAVE ADEQUATE VENTILATION. CLEANING FIREARMS IN POORLY VENTILATED AREAS, DISCHARGING FIREARMS, OR HANDLING AMMUNITION MAY RESULT IN EXPOSURE TO LEAD AND OTHER SUBSTANCES KNOWN TO CAUSE BIRTH DEFECTS, REPRODUCTIVE HARM, AND OTHER PHYSICAL INJURY. WASH HANDS THOROUGHLY AFTER EXPOSURE.

CAUTION: Always follow the instructions provided with your gun cleaner and gun lubricant.

CAUTION: Some cleaners can cause damage to your firearms. You should avoid prolonged solvent immersion and prolonged ultrasonic cleaning of your firearm. Choice of solvent should be restricted to those products specifically developed for firearms maintenance. Damage to a firearm's finish may occur if these cautions are ignored. Ammoniated solvents or other strong alkaline solvents, should not be used on any Smith & Wesson® firearm.

- Cleaning is essential to ensure the proper functioning of your firearm.

CLEANING AND MAINTENANCE - CONTINUED

- Your firearm is a precision instrument. To ensure reliable function it is necessary to follow a routine maintenance procedure. After firing your firearm, be sure to unload it following the procedure outlined in the Unloading section of this manual (page 23) before performing any cleaning or maintenance procedure.
- Remove any gun cleaning solution, oil and fingerprints from the outside surfaces of the firearm. Finger moisture, if left, could start a corrosion process.



WARNING: NEVER MANIPULATE, ADJUST OR CHANGE ANY OF THE INTERNAL COMPONENTS OF YOUR FIREARM UNLESS SPECIFICALLY DIRECTED TO DO SO IN THIS MANUAL.

IMPROPER MANIPULATION OF ANY INTERNAL COMPONENT MAY AFFECT THE SAFETY AND RELIABILITY OF YOUR FIREARM AND MAY CAUSE INJURY OR DEATH.



WARNING: ANY MAINTENANCE OR SERVICE NOT SPECIFIED IN THIS MANUAL MUST BE PERFORMED BY A QUALIFIED GUNSMITH USING GENUINE SMITH & WESSON® PARTS. IF YOU DO OTHERWISE, IMPROPER FUNCTIONING OF YOUR FIREARM MAY OCCUR AND INJURY OR DEATH MAY RESULT.

- If your firearm will be used in a cold climate, be sure to use an oil of an appropriate weight so that it will not congeal in cold temperatures, causing the interaction of important parts to be slowed or halted.

MAINTENANCE BEFORE STORAGE

- When storing, do not encase your firearm in anything that will attract or hold moisture, for example, leather or heavy cloth. Also, do not store guns with a plug inserted in the barrel for this can be a contributing factor to moisture accumulation. If your firearm is to be stored for an extended period, the bore, chambers and internal working mechanism should be oiled with a high quality lubricating oil or preservative intended for firearms. The external working mechanisms and barrel should be coated with an anti-rust oil. Before using your firearm again, be sure to clean it. Every time you clean your firearm, check it for signs of wear. If wear is noted, do not use the firearm, return it to Smith & Wesson® for service or have it checked by a qualified gunsmith.



LIMITED WARRANTY

For Owners Within The United States

This warranty is granted by Smith & Wesson® Brands Inc. This warranty is effective from the date of purchase and applies to the original owner of the firearm. With respect to such firearms, this warranty supersedes any and all other warranties.

Smith & Wesson® firearms are warranted to be free from defects in material and workmanship. Any such defects of which Smith & Wesson® receives written notice within one year from the date of purchase by the original owner, will be remedied by Smith & Wesson® without charge within a reasonable time after such notification and delivery of the firearm as provided below.

In the event of an emergency (repairs needed by law enforcement, an upcoming match or hunting trip), call 1-800-331-0852, ext. 4125 and ask for 911 Priority Repair Service. This allows you to speak with a Smith & Wesson® representative. Immediately upon receipt, your firearm will be assigned to a gunsmith. After the work is completed, we will return your Smith & Wesson® firearm via overnight delivery.

Warranty claims (in writing) and the firearm concerned should be delivered to Smith & Wesson's Customer Service Department, 2100 Roosevelt Avenue, Springfield, Massachusetts 01104. In addition, a copy of the bill of sale in the owner's name, or a copy of ATF Form 4473 indicating date of purchase must be included. It is important that the owner comply with all applicable federal, state and local laws and regulations in the shipment of firearms to Smith & Wesson®.

NOTE: See the Contact and Shipping Section of this manual for further details regarding returns (page 43).

Warranty claims should state the model and serial number of the firearm concerned and the description of the difficulty experienced. It is recommended that shipments be insured by the owner, since Smith & Wesson® will accept no responsibility for loss or damage in transit. Transportation and insurance charges for return to owner will be paid by Smith & Wesson® if the claim is covered by the warranty.

UNDER NO CIRCUMSTANCES SHALL SMITH & WESSON® BE RESPONSIBLE FOR INCIDENTAL OR CONSEQUENTIAL DAMAGES WITH RESPECT TO ECONOMIC LOSS, INJURY, DEATH OR PROPERTY DAMAGE, WHETHER AS A RESULT OF BREACH OF THIS WARRANTY, NEGLIGENCE OR OTHERWISE.

Some states do not allow the exclusion or limitation of incidental or consequential damages, so the above limitation or exclusion may not apply to you.





LIMITED WARRANTY FOR OWNERS WITHIN THE UNITED STATES - CONTINUED

Smith & Wesson® will not be responsible for:

- Defects or malfunctions resulting from careless handling, unauthorized adjustments or modifications made or attempted by anyone other than a qualified gunsmith following Smith & Wesson® authorized procedures, or failure to follow the disassembly instructions in the Smith & Wesson® Safety and Instruction Manual.
- Use of defective or improper ammunition, corrosion, neglect, abuse, ordinary wear and tear, or unreasonable use.
- Criminal misuse, negligence or use under the influence of drugs or alcohol.

Smith & Wesson's Lifetime Service Policy begins after the warranty period has expired. Smith & Wesson® will repair, without charge, for the lifetime of the original owner, any Smith & Wesson® M&P® 22 MAGNUM, that is found to have a defect in material or workmanship. Eligibility for this Lifetime Service Policy requires returning the Product Registration Card within 30 days of purchase. The Lifetime Service Policy covers functional defects; it does not include the firearm's finish, grips, magazines or sights. The Lifetime Service Policy is in addition to and not an extension of the Smith & Wesson® Warranty. This warranty gives you specific legal rights. You may also have other rights that vary from state to state.

NOTE: All liability is excluded in the event that the instructions in the Smith & Wesson® Safety and Instruction Manual are not observed.

CONTACT AND SHIPPING INFORMATION For Owners Within The United States

NOTE: A Return Merchandise Authorization (**RMA**) is the first step in the process of returning a product in order to receive a repair, replacement or refund. Please contact Smith & Wesson's Customer Service Dept. (via e-mail: qa@smith-wesson.com or by phone at 800-331-0852 ext. 4125) to obtain authorization to return your firearm so we can process it quickly and efficiently. The RMA number that is supplied by Smith & Wesson must be displayed on the outside of the returned product's packaging; returns without an RMA number will be routed differently which will result in delayed processing.

The Return Merchandise Authorization (**RMA**) process allows Smith & Wesson® an opportunity to try to diagnose and correct a customer's concerns with the product (such as ammunition problems) before it is returned. Accordingly, please contact us before returning your Smith & Wesson firearm.

CONTACT AND SHIPPING INFORMATION FOR OWNERS WITHIN THE UNITED STATES - CONTINUED

CONTACT CUSTOMER SERVICE
Tel: 800-331-0852 ext. 4125
E-mail: qa@smith-wesson.com

RETURNS - FOR SERVICE

ALL SMITH & WESSON FIREARMS

Smith & Wesson
2100 Roosevelt Avenue
Springfield, MA 01104

Should your Smith & Wesson® firearm require service, it should be returned to the Smith & Wesson factory.

- Call or e-mail the Customer Service Dept. for authorization and shipping instructions.
- Ensure that the firearm is unloaded.
- Do not attempt to ship a firearm via US Postal Service; only federally licensed dealers may ship a firearm by US Postal Service.
- **DO NOT SHIP ANY AMMUNITION.**
- Enclose a letter which includes your full name and address (no P.O. Boxes, please), daytime telephone number, e-mail address, the serial number of the firearm, and details of the problem experienced (stating the brand and type of ammunition used when the problem occurred) or work desired.
- Record the serial number before shipping, in case you wish to check on the repair status of your firearm.
- Please remove all custom parts and accessories, such as special sights and optics, or holsters from your firearm before returning.
- Place the firearm in its original case or in a similarly secure container and pack it securely.
- The package must **NOT** bear any markings which indicate the identity of the contents.
- It is most important that you comply with federal, state, and local laws and regulations. The following guidelines are meant to help, but you must seek assistance from the appropriate authorities if necessary.

CONTACT AND SHIPPING INFORMATION FOR OWNERS WITHIN THE UNITED STATES - CONTINUED

- If your firearm must be replaced, it may be necessary to ship the replacement to a dealer rather than directly to you. You will be requested to furnish a signed FFL (Federal Firearms License) from your dealer in such an instance.
- Warranty repair work will begin upon receipt and examination of the firearm. In the case of repairs or work not covered by the warranty, a quotation covering the cost of the work plus round trip transportation charges will be sent to you. Repairs or modification will be scheduled upon receipt of payment.



WARNING: YOU MAY PURCHASE ACCESSORIES FOR YOUR FIREARM. YOU MUST HAVE SOME OF THESE PARTS INSTALLED BY A GUNSMITH QUALIFIED TO PERFORM SERVICE ON SMITH & WESSON FIREARMS. YOU MUST NEVER ATTEMPT TO MODIFY YOUR FIREARM OR INSTALL REPLACEMENT PARTS IN YOUR FIREARM. ALWAYS USE A QUALIFIED SMITH & WESSON® GUNSMITH EVEN IF THE REPAIR SEEMS SIMPLE.

OPTICAL SIGHT MOUNTING INSTRUCTIONS



WARNING: ALWAYS KEEP YOUR PISTOL POINTED IN A SAFE DIRECTION. NEVER POINT A FIREARM AT ANYTHING YOU DO NOT INTEND TO SHOOT.



WARNING: ALWAYS MAKE SURE THAT THE GUN IS UNLOADED AND THE CHAMBER IS CLEAR BEFORE ANY ACCESSORIES ARE INSTALLED OR ANY ADJUSTMENTS ARE MADE.



WARNING: WEAR SAFETY GLASSES SPECIFIED FOR USE WITH FIREARMS WHEN INSTALLING OR REMOVING THE OPTICAL SIGHT OR WHEN FIRING YOUR PISTOL WITH THE OPTICAL SIGHT INSTALLED.



WARNING: A SIGHT WHICH IS NOT MOUNTED SECURELY MAY BECOME DETACHED UPON RECOIL OF THE FIREARM. IF IT BECOMES DETACHED IT MAY FLY BACK AND STRIKE THE SHOOTER AND/OR A BYSTANDER AND CAUSE INJURY. OBSERVE THE CONDITION OF THE MOUNTING SCREWS BEFORE AND AFTER FIRING. IF THE MOUNTING SCREWS SHOW SIGNS OF BEING LOOSE BEFORE FIRING OR LOOSENING UPON FIRING DO NOT FIRE THE PISTOL UNTIL YOU HAVE TIGHTENED THE SCREWS. THE USER MUST ENSURE THAT THE SCREWS ARE INSTALLED PROPERLY (NOT CROSS-THREADED OR STRIPPED) AND KEPT TIGHT DURING USE.



WARNING: FAILURE TO HEED THESE WARNINGS MAY RESULT IN INJURY AND/OR DEATH TO THE USER AND/OR BYSTANDERS AND DAMAGE TO PROPERTY.

NOTE: An optical sight can be installed or removed with the pistol fully assembled or field-stripped (FIGURE 97).

M&P® 22 MAGNUM MODEL SHOWN WITH OPTICAL SIGHT MOUNTED

Optical Sight (sold separately)
shown here
mounted in slide cut



FIGURE 97

OPTICAL SIGHT MOUNTING INSTRUCTIONS - CONT'D

OPTICAL SIGHT MOUNTING

- Remove hex screws with 5/64" Allen wrench and lift slide cover off - set it aside (FIGURES 98 and 99).
- Set the sight into position on the slide, taking care to seat the sight fully onto the alignment pegs (identified in FIGURE 98).
- Reference the instructions and warnings supplied by the manufacturer of the optical sight. Install the optical sight using the screws that were provided with the sight, and tighten them carefully to avoid cross-threading or stripping them.

NOTE: We recommend that the slide cap cover be installed when an optical sight is not installed, debris may get into the slide if the holes are not covered or filled with screws.

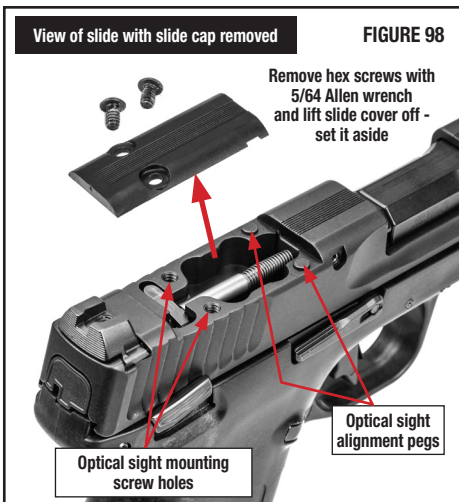



CUSTOM SERVICE

- We understand that Smith & Wesson® gun owners may want to enhance their guns with custom gunsmithing, refinishing or accessories. Our gunsmiths offer specialized services and exclusive products to enhance your shooting experience.
- Accessories for your Smith & Wesson® firearm are available from your local Smith & Wesson Stocking Dealer, or directly from Smith & Wesson®.
- Contact the Smith & Wesson® Customer Service Department at 1-800-331-0852, ext. 4125 for information about these services.
- When ordering directly from the factory, please provide the following information:
 - Model Number
 - Dash Number
 - Serial Number
 - Approximate date of purchase
 - Complete Return Address
 - VISA/Discover/MasterCard Number & Expiration Date
 - For Foreign Orders Only, Fax Number or E-mail Address



BATTERY WARNINGS



WARNING: IF A BATTERY OPERATED ACCESSORY OR ATTACHMENT (I.E. LASER, OPTICAL SIGHT OR FLASHLIGHT, ETC.) IS SUPPLIED OR USED WITH THIS FIREARM, THE FOLLOWING WARNINGS AND INSTRUCTIONS MUST BE ADHERED TO.



WARNING: KEEP BATTERIES AWAY FROM CHILDREN. THERE IS A CHEMICAL BURN HAZARD ASSOCIATED WITH BATTERIES.



WARNING: IF A NEW OR USED LITHIUM BUTTON/COIN CELL BATTERY IS SWALLOWED OR ENTERS THE BODY, IT CAN CAUSE SEVERE INTERNAL BURNS AND CAN LEAD TO DEATH IN AS LITTLE AS 2 HOURS. ALWAYS COMPLETELY SECURE THE BATTERY COMPARTMENT. IF THE BATTERY COMPARTMENT DOES NOT CLOSE SECURELY, STOP USING THE PRODUCT, REMOVE THE BATTERIES, AND KEEP IT AWAY FROM CHILDREN. IF YOU THINK BATTERIES MIGHT HAVE BEEN SWALLOWED OR PLACED INSIDE ANY PART OF THE BODY, SEEK IMMEDIATE MEDICAL ATTENTION.

- When used correctly, batteries provide a safe and dependable source of portable power. However, misuse or abuse may result in leakage, fire, or explosion.
- Batteries can explode or leak and cause burns if installed backwards, disassembled, charged, or exposed to water, fire or high temperature.
- Always take care to install your batteries correctly observing the “+” and “-” marks on the battery and the device.
- Always replace the whole set of batteries at one time, taking care not to mix old and new batteries, or batteries of different types.
- Store unused batteries in their original packaging and away from metal objects that may short-circuit them.
- Remove discharged batteries from equipment promptly to avoid possible damage from leakage.
- Never dispose of batteries in fire. Failure to observe this precaution may result in an explosion.
- The batteries are supplied in a charged state and are not designed for recharging. Recharging may cause leakage, fire, or explosion.
- The batteries should be disposed of properly, including keeping them away from children.
- Dispose of used batteries immediately. Even used batteries may cause injury.



INTERNATIONAL WARRANTY CENTERS

For Owners Outside The United States

NOTE: Addresses and contact information for International Warranty Centers is available on the Smith & Wesson website at www.smith-wesson.com or by calling Customer Service toll-free at 1-800-331-0852 ext 4125.

PATENT INFORMATION

- This product may be covered by one or more patents. Visit <https://www.smith-wesson.com/company/virtual-patent-marking>



This handgun is not equipped with a device that fully blocks use by unauthorized users. More than 200,000 firearms like this one are stolen from their owners every year in the United States. In addition, there are more than a thousand suicides each year by younger children and teenagers who get access to firearms. Hundreds more die from accidental discharge. It is likely that many more children sustain serious wounds or inflict such wounds accidentally on others. In order to limit the chance of such misuse, it is imperative that you keep this firearm locked in a secure place and take other steps necessary to limit the possibility of theft or accident. Failure to take reasonable preventative steps may result in innocent lives being lost, and in some circumstances may result in your liability for these deaths.

The certification below is required only for handguns sold in the United States with a barrel length shorter than 3".

Smith & Wesson Inc. hereby certifies average accuracy test results for all new handguns with a barrel shorter than 3" as follows:

7 yards
1.7"

14 yards
3.9"

21 yards
6.3"

This certification is based on tests conducted by Smith & Wesson Inc. using a fixed handgun rest and firing ammunition manufactured by a member of the Shooting Arms and Ammunition Manufacturers Institute (SAAMI) as defined in ANSI/SAAMI Z299.3-1993.

This certification represents actual tests based on several handguns, selected at random. Your particular handgun may have accuracy better than the results stated in this certification.



Smith & Wesson[®]

EMPOWERING AMERICANS™



3015933

Smith & Wesson[®]

2100 Roosevelt Avenue • Springfield, MA 01104

www.smith-wesson.com

p/n 3015933

REV: M&P22_MAGNUM_04042023